

R. C. Tronics Incorporated

2573 East Kercher Road
Goshen, Indiana 46528
Toll Free 1-866-457-7790

Phone 1-574-642-3857
Fax 1-574-642-3858
<http://www.rctronics.com>

RCT-02015-R

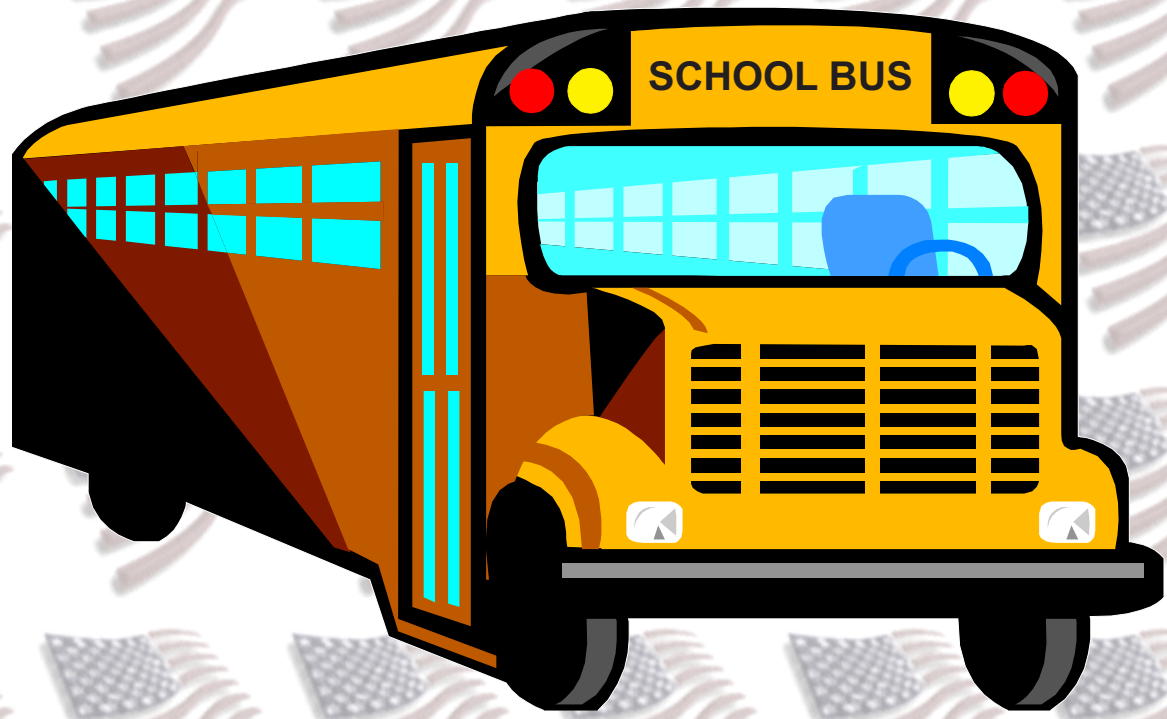

SCHOOL BUS ELECTRONIC DISTRIBUTION SYSTEM



R. C. Tronics, Incorporated

2573 East Kercher Road
Phone 1-574-642-3857
Toll Free 1-866-457-7790

www.rctrionics.com

Goshen, Indiana 46528
Fax 1-574-642-3858
dchiddister@rctrionics.com

Highlighted Features in the RCT-02015-R School Bus System.

- ***8 Ignition Circuits.***
- ***2 Stop Arm Outputs.***
- ***Child-Check-System.***
- ***Noise Cancel Circuits.***
- ***5 Battery Hot Circuits.***
- ***Starter Interrupt Circuit.***
- ***Built in Door Limit Circuits.***
- ***24 Battery Negative Circuits.***
- ***Crossing Arm Inhibit System.***
- ***Lift Enable & Shift Lock Interface.***
- ***Lift Enable & Shift Lock Indicators.***
- ***Inputs for Red, Amber, & Strobes with Indicator's.***
- ***Direct Interface with RCT-01727-A, / 8-Way Bus Warning Light with Bulb Out Indicators System and Dual Stop Arm Outputs.***
- ***Inputs for Alarm-1, Roof Hatch, Rear Door, Egress Window, Lift Door, & Vandal Lock with Indicators.***
- ***Zero Current Draw when control in static state.***

DASH SWITCH PANEL (9.5 X 7.65)
 SWITCH PCB-STF-01919 (6.2 X 4.2)
 ADA PCB-STF-01010 (.8 X 3.3)
 SHOWN 75% SCALE

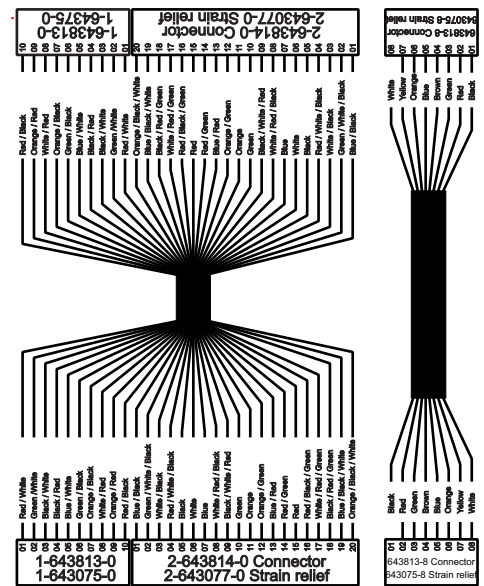
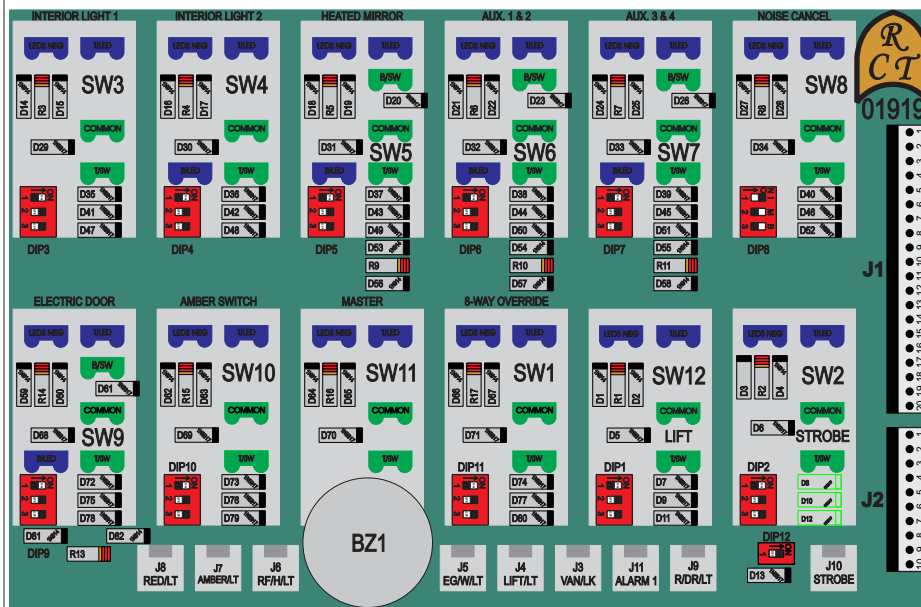
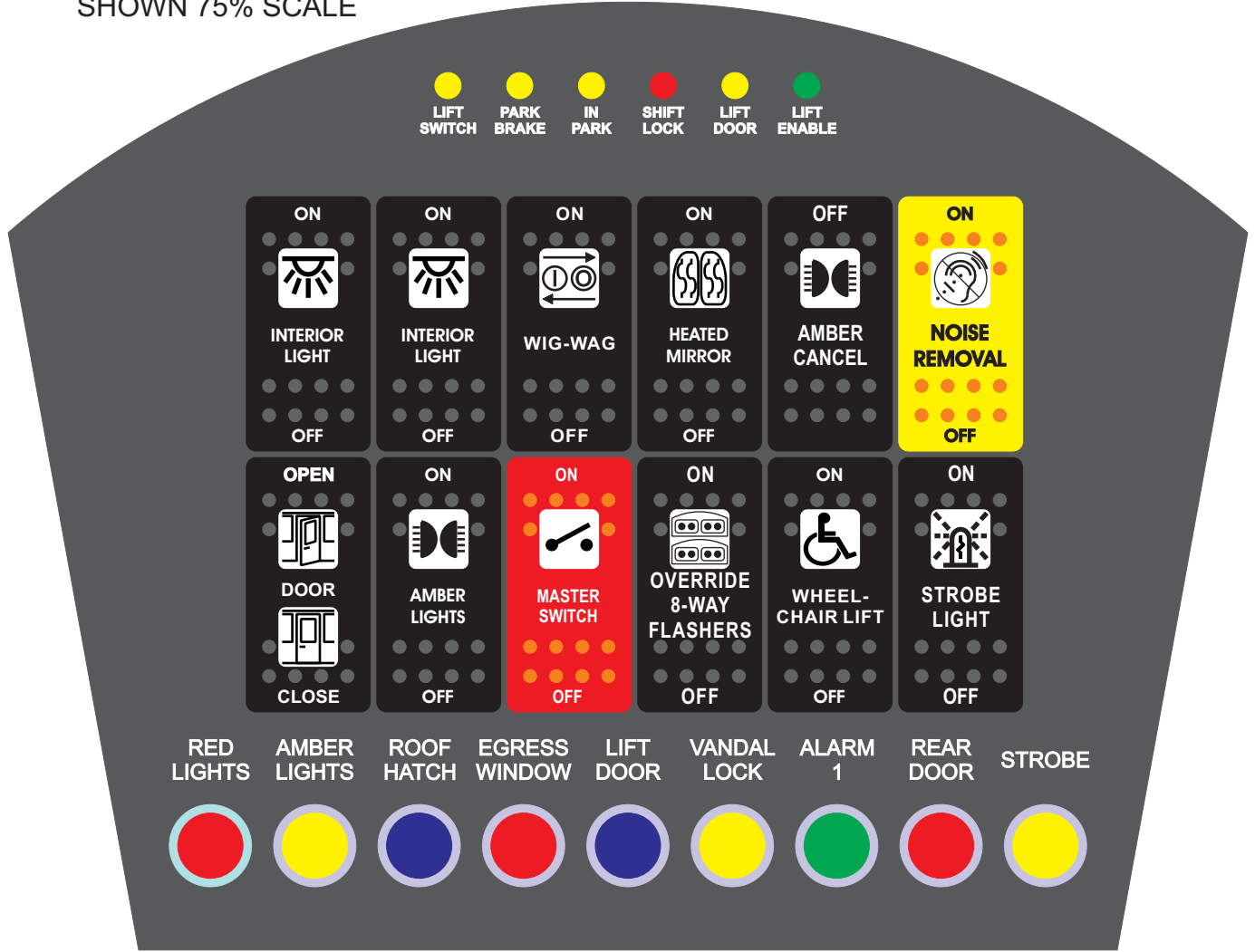
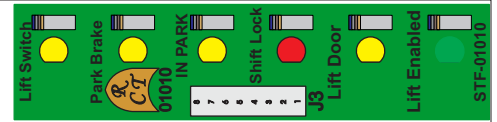

Switch loads may be operated by; Ignition, DIP 1; Ignition with Master Switch, DIP 2; (or) Battery, DIP 3.

DAT-01352-00XX0 DAT-01348
 (XX = FEET OF CABLE) -00XX0

**RCT-MOLEX- 00016
MATING HARNESS
CONNECTOR KIT**

CN01
Door Outputs
with Door Limits.

DIP SWITCH 10
Inhibits
"DOOR OPEN"
without vehicle
"IN PARK".

CN02
Outputs from
switch panel.

CN03
Input and
Outputs for Dual
Stop Arm.

CN04
Outputs from
switch panel.

CN05
Outputs from
switch panel.

CN06
Fan High Output.
Fan Medium Output.
Input J3, pin 1&2.

DIP7
Battery Enabled;
Interior Lights,
Switch 5

10 second Timer On,
Switch 4.

Interior 2 Light On
Switch 3.

Interior 1 Light On
Switch 2

Door Light On
Switch 1.

Ext. Door Control
J6-01 - Close

J6-02 - Open

J6-03 - +12 VDC

J6-04 - Negative

J7
RCT-01727-A
8-WAY WIGWAG
INTERFACE

CN18
Brake Light
Input to Amber Light.
Input to Red Indicator.
Input to Strobe Indicator.
Provides Negative output, SW01

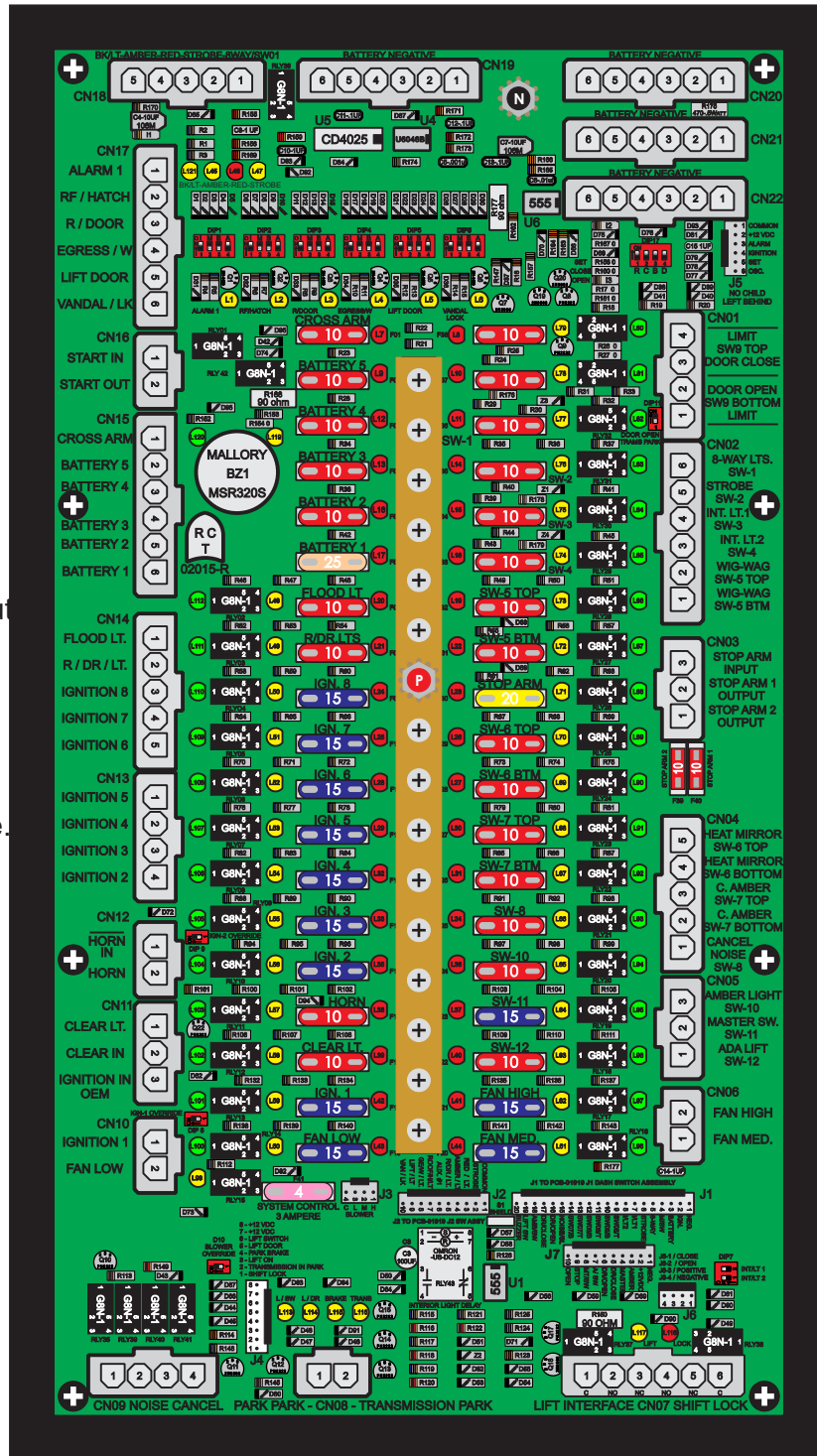

CN17
Alarm Inputs
to ground.
Operation dip
switch selectable;
Ignition, Master
Switch or Battery.
Alarm 1

Roof Hatch
Rear Door
Egress Window
Lift Door
Vandal Lock.

CN16
Engine Start only
with R/DOOR input.

CN15
Battery
1 thru 5 Output.
Cross Arm Output

CN14
Lift Flood Output
Rear Door Light Output
Ignition 6 thru 8
Output.

CN13
Ignition 2 Output
"OFF" w / SW09
DIP Switch 9, override.
Ignition 3 thru 5

CN12
Horn Input
and
Horn Output.

CN11
Clearance Output
Clearance Input
and
Ignition Input.

CN10
Ignition 1 Output
"OFF" w / SW09
DIP SW8, override.
Fan Low output.

CN09
Opens 4 Negative
returns, SW09

DIP SWITCH 10
Removes Low-Medium-High
Fan with "Noise Cancel Switch

CN08
Park Brake Input
and
Transmission Input

CN07
Lift Interlock Output
and
Shift Lock Output.

CONTROLS SHOWN 50% OF ACTUAL SIZE: RCT-02015 9 x 16 INCHES

DIP 1 THRU 6 LOCATED IN THE UPPER LEFT CORNER OF BOARD

NOTE:

*PROTRUDING DIP-SWITCH TABS ARE ADJUSTMENT TABS SHOWN IN BLACK.
"ON & OFF" IS DEFINED IN BLACK ON WHITE BACKGROUND.*

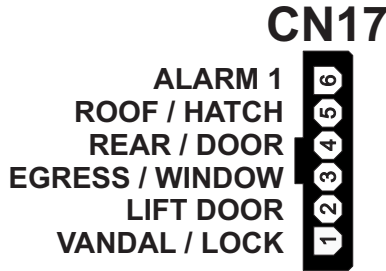

Dip Switch, "ON", you may select the following.

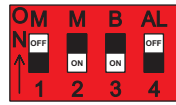

- 1 - Ignition Enabled.
- 2 - Master Switch Enabled.
- 3 - Battery Enabled.
- 4 - Audible Alarm Enabled.

- DIP1 - ALARM 1:** Typically used for; "EMERGENCY EXIT ALARM". Negative (-) input at CN17-6 to activate.
- DIP2 - ROOF HATCH:** Typically used for; "ROOF HATCH OPEN ALARM". Negative (-) input at CN17-5 to activate.
- DIP3 - REAR DOOR:** Typically used for; "REAR DOOR OPEN ALARM". Negative (-) input at CN17-4 to activate.
- DIP4 - EGRESS WINDOW:** Typically used for; "EGRESS WINDOW OPEN ALARM". Negative (-) input at CN17-3 to activate.
- DIP5 - LIFT DOOR:** Typically used for; "LIFT DOOR OPEN ALARM". Negative (-) input at CN17-2 to activate.
- DIP6 - VANDAL LOCK:** Typically used for; "VANDAL LOCK ALARM". Negative (-) input at CN17-1 to activate.

DIP 7 Located;
Lower Right Corner of Board.
Dip Switch, Enables, "Dome Lights",
LT-1 and LT-2, timed, delay, "OFF".



DIP 17 Located;
Upper Right Corner of Board.
This Dip Switch, "Enables, "Childminder".

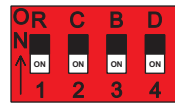

- 1 - CN18-3 - Red Lights.
- 2 - CN11- 2 Clear Light In.
- 3 - CN18-5 Brake Lights.
- 4 - Door Open, Sw09 (BTM).

DIP 8 Located;
Lower Left of Board by CN10-1

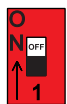

Dip Switch, "OFF"
Enables, Ignition
Output @ CN01-1 .



Dip Switch, "ON"
Output @ CN10-1.
Noise Cancel Switch,
"ON" (SW09).

DIP 9 Located;
Lower Left of Board by CN12-1



Dip Switch, "OFF"
Enables, Ignition
Output @ CN13-4.



Dip Switch, "ON"
Output @ CN13-4.
Noise Cancel Switch,
"ON" (SW09).

DIP 10 Located;
Lower Left of Board by J4



Dip Switch, "ON" Overrides
Noise Cancel Switch, SW09
for, Blower Motor Operation,
Fan-Low-Medium-High.

DIP 11 Located;
Mid Right of Board by CN01



Dip Switch, "OFF" Inhibits
"DOOR OPEN" @ CN01-2.
"TRANSMISSION PARK",
@ CN08-2, (SINK).

R. C. Tronics, Incorporated

2573 East Kercher Road
Phone 1-574-642-3857
Toll Free 1-866-457-7790

www.rctronics.com

Goshen, Indiana 46528
Fax 1-574-642-3858
dchiddister@rctronics.com

RCT-02015-R School Bus Electronic Distribution System

- CN01-4 Door is closed limit switch input, to battery negative.
- CN01-3 SW-09, bottom Door close to motor, 12 VDC @ 20 ampere output. (Return CN01-2)
- CN01-2 SW-09 top Door open to motor, 12 VDC @ 20 ampere output. (Return CN01-3)
- CN01-1 Door is open limit switch input, to battery negative.

Operation of the above circuits is accomplished by the operation of “DOOR SWITCH, OPEN & CLOSE”, which is a momentary on-off-on. Limiting door travel is accomplished with limit switch inputs. Placing “DIP SWITCH 11” in the “OFF” position will cause the door to be enabled only with a input to “TRANSMISSION PARK” CN08-2. **NOTE: All switch numbers can be found on switch PCB-01919.**

- CN02-6 SW-01 output, +12 @ 20 ampere. (Eight-Way Lights)
- CN02-5 SW-02 output, +12 @ 20 ampere. (Strobe)
- CN02-4 SW-03 output, +12 @ 20 ampere. (Interior Light 1)
- CN02-3 SW-04 output, +12 @ 20 ampere. (Interior Light 2)
- CN02-2 SW-05 top output, +12 VDC @ 20 ampere. (Wigwag)
- CN02-1 SW-05 bottom output, +12 VDC @ 20 ampere. (Wigwag)

NOTE: SW-01 a battery negative, sink 20 ampere is available at CN18-1.

NOTE: All switch numbers can be found on switch PCB-01919.

- CN03-3 Stop Arm input, +12 VDC @ .05 ampere.
- CN03-2 Stop Arm 1 output, +12 VDC @ 10 ampere.
- CN03-1 Stop Arm 2 output, +12 VDC @ 10 ampere.

- CN04-5 SW-06 top output, +12 VDC @ 20 ampere. (Heated Mirror)
- CN04-4 SW-06 bottom output, +12 VDC @ 20 ampere. (Heated Mirror)
- CN04-3 SW-07 top output, +12 VDC @ 20 ampere. (C. Amber)
- CN04-2 SW-07 bottom output, +12 VDC @ 20 ampere. (C. Amber)
- CN04-1 SW-08 output, +12 VDC @ 20 ampere. (Noise Cancel)

- CN05-3 SW-10 output, +12 VDC @ 20 ampere. (Amber Light)
- CN05-2 SW-11 output, +12 VDC @ 20 ampere. (Master Switch)
- CN05-1 SW-12 output, +12 VDC @ 20 ampere. ADA Lift)

NOTE: All switch numbers can be found on switch PCB-01919.

- CN06-2 Fan High output, +12 VDC @ 20 ampere.
- CN06-1 Fan Medium output, +12 VDC @ 20 ampere.

All fan outputs are controlled at J3-1, battery negative; J3-2, fan low; J3-3 fan medium; J3-4, fan high. All inputs at J3 are to J3-1, battery negative. Placing “DIP SWITCH 10” in the “ON” position will cause the fans to be turned off when switch 8 is turned on. Ignition 1 power will be removed unless “DIP SWITCH 8” is placed to the “ON” position. (Noise Removal Switch).

- CN07-6 Shift Lock common, 20 amperes.
- CN07-5 Shift Lock normally closed, 20 amperes.
- CN07-4 Shift Lock normally opens, 20 amperes.
- CN07-3 Lift Interface normally closed, 20 amperes.
- CN07-2 Lift Interface normally opens, 20 amperes.
- CN07-1 Lift Interface common, 20 amperes.

Shift lock output is enabled and identified with a red led with inputs from CN08-2, transmission park or CN17-5, lift door. An additional input to CN08-1 park brake will provide a lift interface output with a green led indication.

- CN08-2 Transmission Park input, to batter negative.
- CN08-1 Park Brake input, to battery negative.

- CN09-1 Noise Cancel, 10 amperes, to battery negative.
- CN09-2 Noise Cancel, 10 amperes, to battery negative.
- CN09-3 Noise Cancel, 10 amperes, to battery negative.
- CN09-4 Noise Cancel, 10 amperes, to battery negative.

Circuits are normally closed they will open with the operation of switch 08 which is normally labeled “NOISE CANCEL”. Total circuit will accommodate a total of 25 amperes.

- CN10-2 Fan Low output, + 12 VDC @ 20 amperes.
- CN10-1 Ignition 1 output, +12 VDC @ 20 ampere.

- CN11-3 Ignition input, +12 VDC @ .5 ampere.
- CN11-2 Clearance input, +12 VDC @ .05 ampere.
- CN11-1 Clearance output, +12 VDC @ 20 ampere.

- CN12-2 Horn output, +12 VDC @ 20 ampere.
- CN12-1 Horn input, battery negative @ .05 ampere.

- CN13-4 Ignition 2, +12 VDC @ 20 ampere.
- CN13-3 Ignition 3, +12 VDC @ 20 ampere.
- CN13-2 Ignition 4, +12 VDC @ 20 ampere.
- CN13-1 Ignition 5, +12 VDC @ 20 ampere.

Ignition 2 power will be removed with the operation of switch 8, normally called “NOISE REMOVAL”.

- CN14-5 Ignition 6, +12 VDC @ 20 ampere.
- CN14-4 Ignition 7, +12 VDC @ 20 ampere.
- CN14-3 Ignition 8, +12 VDC @ 20 ampere.
- CN14-2 Rear Door Flood Output +12 @ 20 ampere. (operates with Rear Door Sw. CN17-3)
- CN14-1 Flood light, +12 VDC @ 20 ampere.

Flood light will sequence on with an input to battery negative at the “LIFT DOOR”, CN17-5.

- CN15-6 Battery 1, 12 VDC @ 20 amperes.
- CN15-5 Battery 2, 12 VDC @ 20 amperes.
- CN15-4 Battery 3, 12 VDC @ 20 amperes.
- CN15-3 Battery 4, 12 VDC @ 20 amperes.
- CN15-2 Battery 5, 12 VDC @ 20 amperes.
- CN15-1 Cross Arm, 12 VDC @ 20 amperes.

Crossing arm output will operate with a door open command. This output can be inhibited by momentary depressing the “DOOR CLOSED” switch and then operating door open within a twelve second time frame causing the buzzer to become active and not permitting the operation of the crossing arm.

- CN16-2 Start Out, +12 VDC@ 20 ampere.
- CN16-1 Start In, +12 VDC @ 20 ampere.

Start circuit active only with no input to, battery negative signal at “VANDAL LOCK”, CN17-6.

- CN17-6 Vandal Lock. (dip switch 6)
- CN17-5 Lift Door. (dip switch 5)
- CN17-4 Egress Window. (dip switch 4)
- CN17-3 Rear Door Sw. (dip switch 3) (operates rear door flood CN14-2)
- CN17-2 Roof Hatch. (dip switch 2)
- CN17-1 Alarm 1. (dip switch 1)

All inputs are to battery negative, sink current is less than .02-amp (20 ma.) operations may be selected via a single dip switch associated with each input. Each input may become active by ignition (I), ignition-master switch (M) or battery (B). The last switch on each dip switch will cause the buzzer to become active with input selected.

- CN18-4 Amber Light Input.
- CN18-3 Red Light Input.
- CN18-2 Strobe Light Input.
- CN18-1 8 Way SW01.

Amber, Red, Strobe light inputs serve only to provide +12 VDC to dash switch, PCB-01919,

J7, J8 and J10 respectively to power indicators. 8 Way SW01 provides a battery negative output, sink 20 amperes when SW01 is activated; additionally, a positive output is presented at CN02-6.

CN19, CN20, CN21 and CN22, Pins 1 through 6 for a total of 24 are connected to battery negative, sink up to 25 amperes.

There are red, amber, and green which are located to the right and left of the bus bar. The red led depicts a fuse open condition. Amber led depicts power relay commanded on. Green led depicts power being supplied to load via connectors.

ADA controls are located at the bottom right of control. Remote signal indicators may be connected to J4 and routed through an eight-pin cable to PCB-01010 showing conditions of all limit switches as well the condition of "SHIFT LOCK" and "LIFT ENABLE.

NOTE:

All switches located on the switch center, PCB-01902, with the exception of "MASTER" may be selected to operate in one of three conditions, ignition, ignition master or battery via 3 position dip switches located on PCB below each switch.

R. C. Tronics, Incorporated

2573 East Kercher Road

Phone 1-574-642-3857

Toll Free 1-866-457-7790

www.rctronics.com

Goshen, Indiana 46528

Fax 1-574-642-3858

dchiddister@rctronics.com

RCT-02015-R POWER CENTER TO RCT-01919 SWITCH CENTER

- J1-01 – Negative (-)
- J1-02 – Ignition (Switched Relay 15) (+12VDC)
- J1-03 – Battery (Fused F4) (+12VDC source)
- J1-04 - SW-11 (Master Switch with Ignition) (+12VDC source)
- J1-05 - SW-1 (8 Way Override) (+12VDC source)
- J1-06 - SW-02 (Strobe) (+12VDC source)
- J1-07 - SW-03 (Interior Light 1) (+12VDC source)
- J1-08 - SW-04 (Interior Light 2) (+12VDC source)
- J1-09 - SW-05(Top) (H/Mirror) (+12VDC source)
- J1-10 - SW-05 (Bottom) (H/Mirror) (+12VDC source)
- J1-11 - SW-06 (Top) (+12VDC source)
- J1-12 - SW-06 (Bottom) (+12VDC source)
- J1-13 - SW-07 (Top) (+12VDC source)
- J1-14 - SW-07 (Bottom) (+12VDC source)
- J1-15 - SW-08 (Noise Cancel) (+12VDC source)
- J1-16 - SW-09 (Top) (Door Open) (+12VDC source)
- J1-17 - SW-09 (Bottom) (Door Close) (+12VDC source)
- J1-18 - SW-10 (Amber Switch) (+12VDC source)
- J1-19 - SW-12 (Lift Switch) (+12VDC source)
- J1-20 –Buzzer (+12VDC source)

RCT-02015-R POWER CENTER TO RCT-01919 SWITCH CENTER

- J2-01 – Negative (-)
- J2-02 - Strobe Light (+12VDC source)
- J2-03 - Red Light (+12VDC source)
- J2-04 - Amber Light (+12VDC source)
- J2-05 - Roof Hatch Light (RF/H/LT) (+12VDC source)
- J2-06 - Aux. 1 Light (+12VDC source)
- J2-07 - Rear Door Light (R/DR/LT) (+12VDC source)
- J2-08 - Egress Window Light (GE/W/LT) (+12VDC source)
- J2-09 - Lift Light LIFT/LT (+12VDC source)
- J2-10 - Vandal Lock Light (VAN/LK) (+12VDC source)

RCT-02015-R POWER CENTER TO BLOWER FAN SPEED SWITCH

- J3-01 - Blower High Speed (- sink)
- J3-02 - Blower Medium Speed (- sink)
- J3-03 - Blower Low Speed (- sink)
- J3-04 - Blower Common (-) (Inhibits blower RLY-41) (Bypass with J3 Blower Override Switch D10)

RCT-02015-R POWER CENTER TO PCB-01010 INDICATOR

- J4-01 - "Shift Lock" Indicator (- sink)
- J4-02 - "Transmission in Park" Indicator (- sink)
- J4-03 - "Lift On" Indicator (- sink)
- J4-04 - "Park Brake Set" Indicator (SW08) (- sink)
- J4-05 - "Lift Door" Indicator (SW17) (- sink)
- J4-06 - "Lift Switch On" Indicator (- sink)
- J4-07 - + 12 VDC
- J4-08 - + 12 VDC

RCT-02015-R POWER CENTER TO PCB-02040 CHILD MINDER SYSTEM

- J5-01 Common, Negative (-)
- J5-02 +12 VDC
- J5-03 Alarm (- sink)
- J5-04 Ignition (Switched Relay 15) (+12VDC)
- J5-05 Set (+12VDC source)
- J5-06 Oscillator (- sink)

RCT-02015-R POWER CENTER TO EXTERNAL DOOR SWITCH

- J6-01 Open Door Input (+12VDC source)
- J6-02 Close Door Input (+12VDC source)
- J6-03 Positive + 12VDC
- J6-04 Negative (-)

RCT-02015-R INTERFACE TO RCT-01727-A

RCT-01727-A SCHOOL BUS ELECTRONIC AMBER and RED WARNING CONTROL with WARNING LIGHT CURRENT MONITORING.

- J7-1 Battery Negative
- J7-2 +12 VDC Positive
- J7-3 Amber Switch Indicator
- J7-4 Master Switch Indicator
- J7-5 Door Close Switch
- J7-6 Door Open Switch
- J7-7 Amber Warning Switch
- J7-8 Master Switch
- J7-9 Stop Crossing Arm
- J7-10 Open, not used.

R. C. Tronics Incorporated

2573 East Kercher Road
Goshen, Indiana 46528
Toll Free 1-866-457-7790

Phone 1-574-642-3857
Fax 1-574-642-3858
<http://www.rctronics.com>

RCT-01727-A SCHOOL BUS ELECTRONIC AMBER & RED WARNING CONTROLLER WITH WARNING LIGHT CURRENT MONITOR.

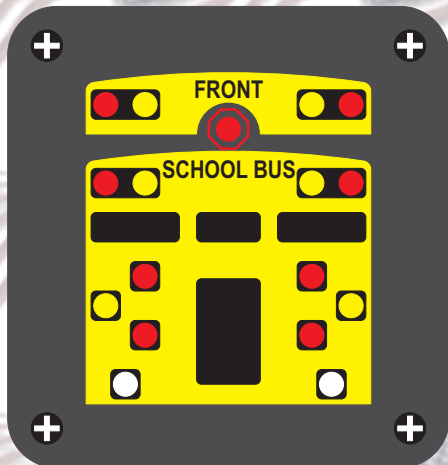
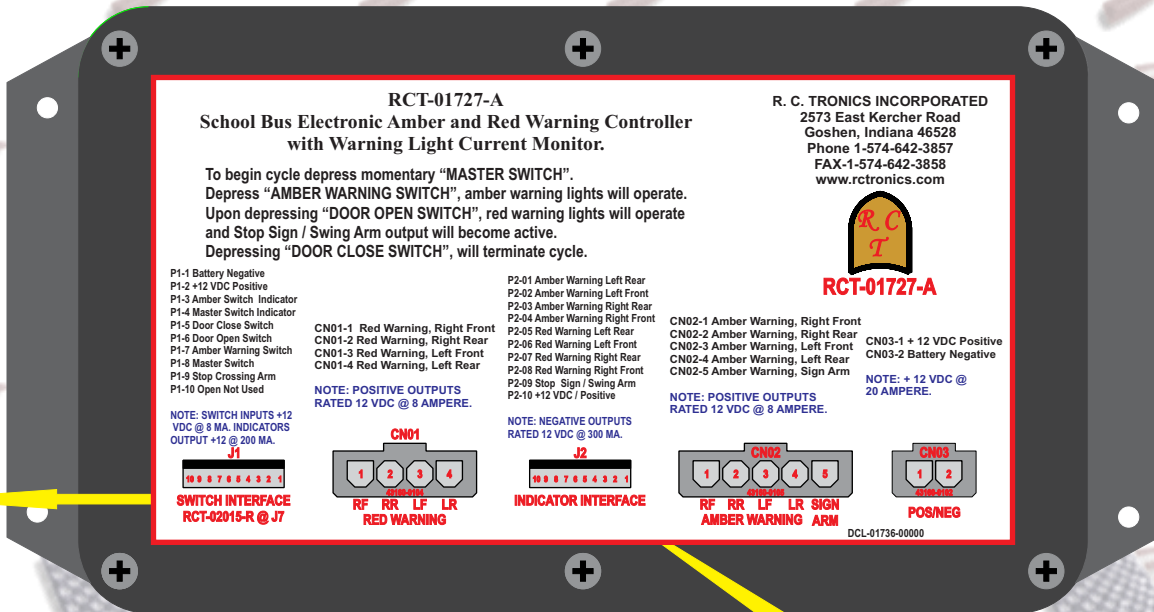

RCT-01729-00000 Indicator Panel,
Use With RCT-01727-A Only.

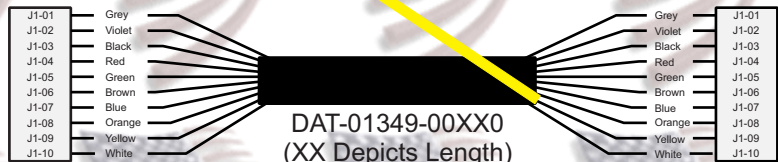

To Monitor Brake, Turn and Back-Up lights requires
RCT-01725 and Indicator Panel RCT-01729-00001.



**INTERFACE FROM RCT-01727-A TO:
RCT-02015-R & ABOVE REVISIONS,
"SCHOOL BUS SYSTEM".**

SEQUENCE OF OPERATION FROM RCT-01919, "DASH SWITCH ARRAY".

- Momentarily depressing, "MASTER" switch will arm system.
- Momentarily depressing, "AMBER WARN" switch will begin operating of the amber warning lights.
- Momentarily inputting to P1-6, "DOOR OPEN" will switch to red warning lights from amber warning lights and output +12 VDC @ CN02-5, "SIGN ARM".
- Momentarily inputting to P1-5, "DOOR CLOSE" will terminate cycle.

R. C. Tronics Incorporated

2573 East Kercher Road
Goshen, Indiana 46528
Toll Free 1-866-457-7790

Phone 1-574-642-3857
Fax 1-574-642-3858
<http://www.rctronics.com>

RCT-02040
CHILD MINDER SWITCH WITH MOUNT COVER

RCT-02289-0__01



FAC-02289-00000

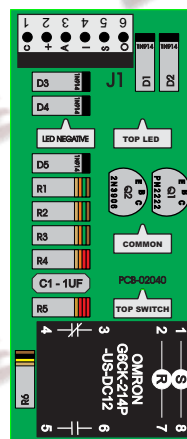

Switch placed in rear of school bus, connected with data cable, DAT-01376-00XX0.
Without, "RESET", vehicle lighting system & vehicle horn will alternate.

R. C. Tronics, Incorporated

2573 East Kercher Road
Phone 1-574-642-3857
Toll Free 1-866-457-7790

www.rctronics.com

Goshen, Indiana 46528
Fax 1-574-642-3858
dchiddister@rctronics.com

RCT-02015-R Childminder and Crossing Arm Inhibit.

Childminder Switch:

- Triggering Conditions- You can trigger the child reminder switch with Brake Lights, Clearance Lights, Red Lights, and Entry Door Open.
- Once triggered and you disengage the ignition. Your interior lights, Horn, and the light in the switch itself will flash. Interior lights flash first then go off. The horn and the light in the switch flash next to after the interior light go off. 30-50 seconds out of phase.
- To inhibit the child reminder, activate the switch in the back of the bus and the child reminder is disengaged.
- With child reminder triggered and the ignition on you can inhibit the child reminder switch in the back of the bus to disengage the child reminder feature.
- If child reminder is not triggered the light in the switch will be lit. Nothing happens at this point if you turn off your ignition.

Crossing Arm Inhibit:

- The crossing arm extends when you activate your stop arm.
- To inhibit the crossing arm, you will need to activate the crossing arm cancel switch.
- If you activate the crossing arm cancel switch you will see a light in the switch, come on. That acts as a crossing arm inhibit activation light, this light will time out (8-10 seconds) and the circuit resets. (**Note: There is no stage lighting in the crossing arm cancel switch**)
- If you activate the crossing arm cancel switch you will inhibit the crossing arm. Extend your stop arm and the crossing arm will not come out. Disengage the stop arm and the circuit resets.
- If you extend your stop arm the crossing arm will come out. If you activate the switch the crossing arm will retract. Disengage the stop arm and the circuit resets.

R. C. Tronics, Incorporated

2573 East Kercher Road
Goshen, Indiana 46528
Toll Free: 1-886-457-7790

Phone: 1-574-642-3857
Facsimile: 1-574-642-3858
<https://www.rctronics.com>

ADA & SHIFT LOCK CIRCUIT – PCB-02015-R

Monday, October 30, 2023

CIRCUIT PURPOSE.

ADA requires vehicles to be rendered static. Therefore, four inputs are required to ensure immobility; Lift Switch, Park Brake Switch Transmission Park Switch and Lift Door Switch.

Four led amber indicators provide visual of switch inputs. Three indicators provide visual depict that; Shift Lock and Lift Interface outputs are available to enable locking of shifting from, park. Lift interface to enable wheelchair lift.

NOTE: Remote Visual Led Indicator (PCB-01010) is available depicting any of the safety inputs.

LIMIT SWITCH INPUTS.

- Lift Switch input from SW12 on PCB-01919 (+12 VDC), Amber led on (L113).
- Park Brake input at CN08-1 (sink), Amber led on (L115).
- Transmission In Park input at CN08-2, (sink), Amber led on (L116).
- Lift Door input at CN17-5, (sink), Amber led on (L114).
- Shift Lock, Relay 38, red led on, (L118).
- Lift Interface, relay 37, green led on, (L117).

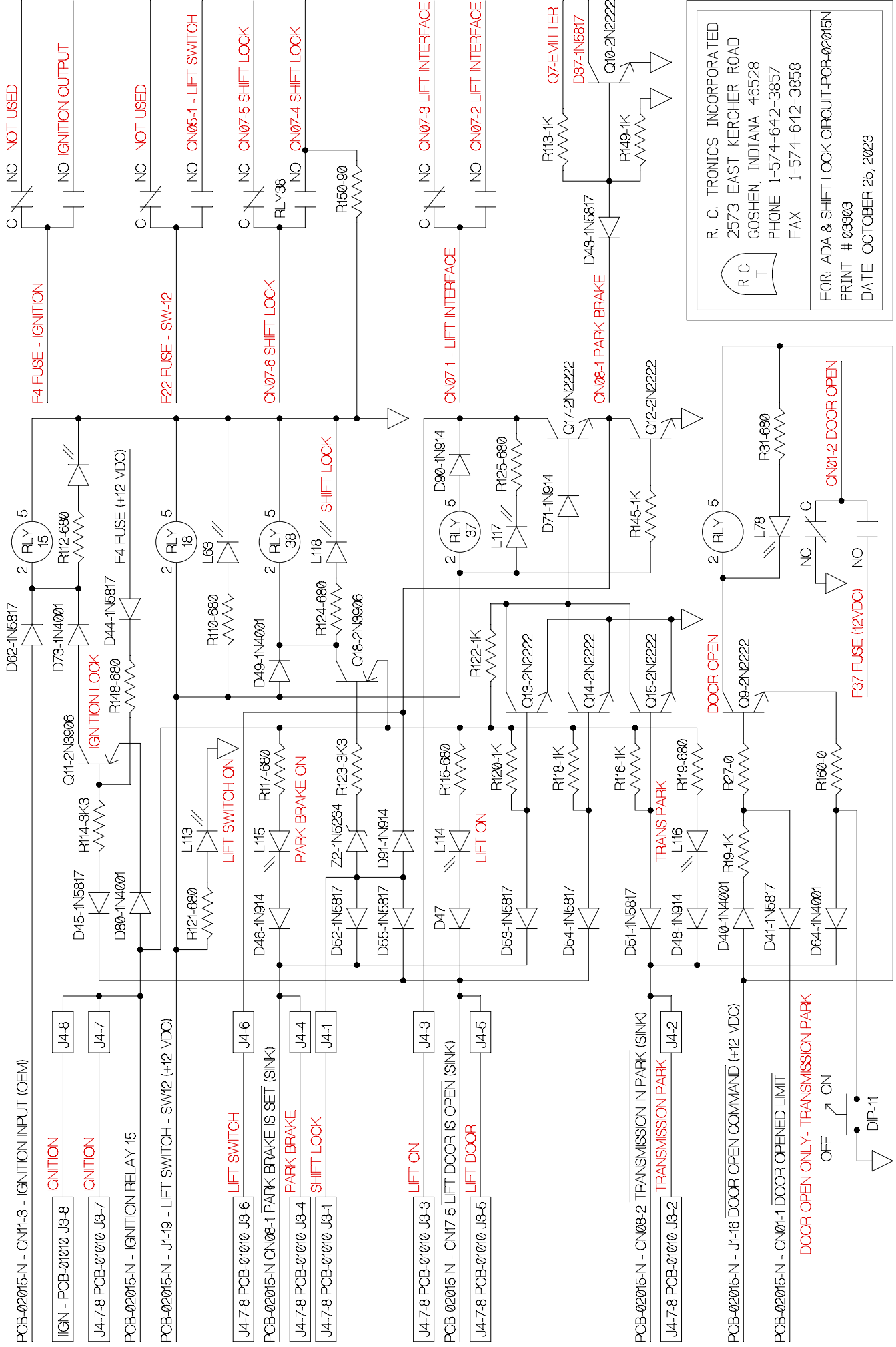

	R. C. TRONICS INCORPORATED	
	2573 EAST KERCHER ROAD	
	GOSHEN, INDIANA 46528	
	PHONE 1-574-642-3857	FAX 1-574-642-3858
FOR: ADA & SHIFT LOCK CIRCUIT PCB-02015N PRINT # 089003 DATE OCTOBER 25, 2023		

R. C. Tronics, Incorporated

2573 East Kercher Road
Goshen, Indiana 46528
Toll Free: 1-886-457-7790

Phone: 1-574-642-3857
Facsimile: 1-574-642-3858
<https://www.rctronics.com>

NOISE CANCEL BLOWER FAN, HIGH-MEDIUM-LOW, WITH BLOWER OVERRIDE.

Monday, October 30, 2023

- Noise cancel switch, “ON” operates relays, 35-39-40-41, removing ground from CN09-1 CN09-2 CN09-3 CN09-4.
- Blower fan relays, 14-16-17, low-medium-high will then de-energize, removing blower fan, low, medium, and high.
- Blower fan, low, medium, and high may be maintained via, D10 placed to the “ON” position.
- Ignition relays, may be converted to, “Noise Cancel” by selecting “OFF” position with DP8 and or DP9.
- Placing DP8 and or DP9 to “ON” position will provide “Ignition” output only.

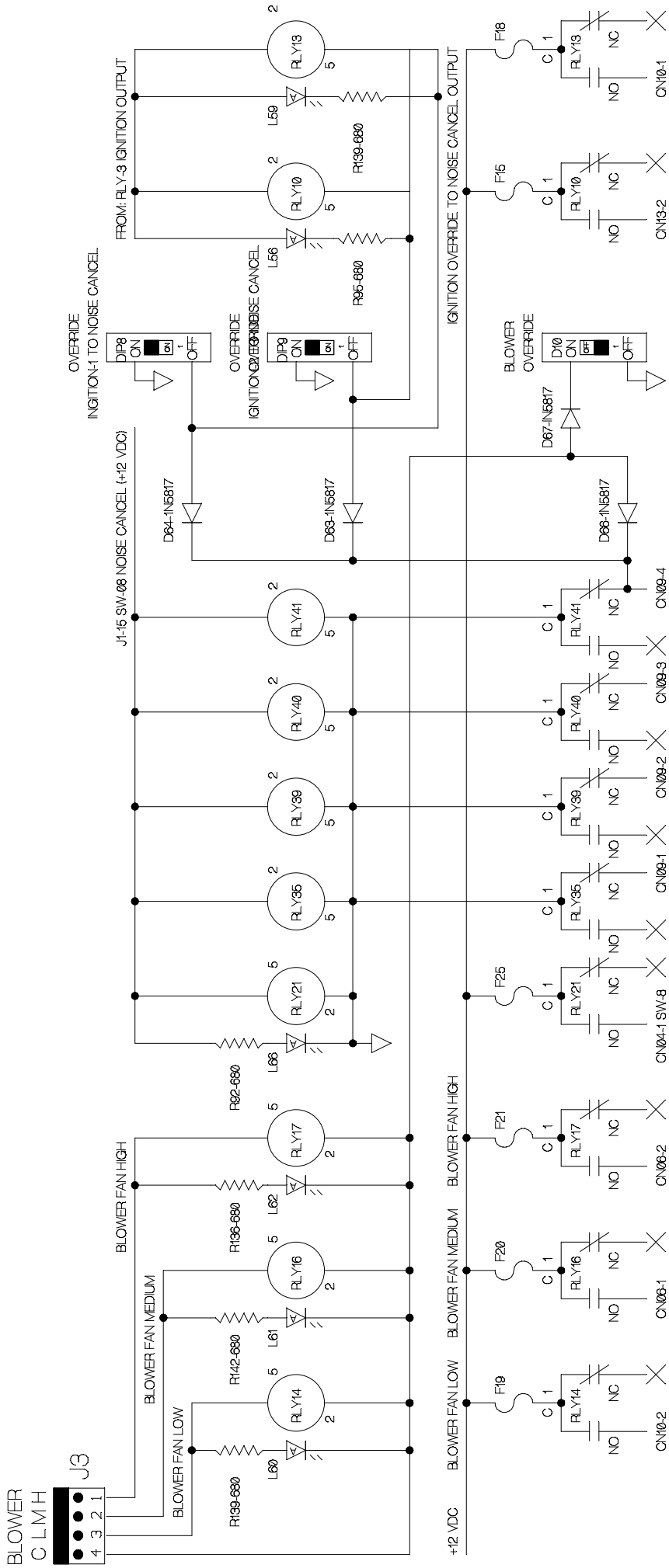

R. C. TRONICS INCORPORATED
 2573 EAST KERCHER ROAD
 GOSHEN, INDIANA 46528
 PHONE 1-574-642-3857
 FAX 1-574-642-3858

FOR: NOISE CANCEL SW-08-BLOWER FAN
 PRINT # 039004
 DATE OCTOBER 30, 2023 (PCB-02016-N)

R. C. Tronics, Incorporated

2573 East Kercher Road
Goshen, Indiana 46528
Toll Free: 1-886-457-7790

Phone: 1-574-642-3857
Facsimile: 1-574-642-3858
<https://www.rctronics.com>

CHILDMINDER & DOME LIGHT TIMER CIRCUITS OPERATION PCB-02040 Monday, October 23, 2023

1. Ignition J5-4 (+12 VDC)
 - Energizes relay 2, opening normally closed contact.
 - Provides +12 VDC to relay 1-8.
 - Provides +12 VDC to “Reset Switch Led”, illumination of switch.
2. Arming Childminder System, “SET”, J5-5, +12 VDC.
 - Sets relay 1-1, closes contact 3 & 4 of “Alarm Latch Relay”.
 - Note: Set input, J5-5 is selected with DP17, located on PCB-02015. Choices are, “Red Light CN18-3”, “Clearance Light CN11-1”, “Brake Light CN18-5”, and “Door Open”. Any one or all may be chosen.
3. Alarm Enabling of Childminder System.
 - Remove, “Childminder Ignition from J5-4”, via vehicle ignition.
 - Relay 2, Alarm Enabled Relay will de-energize, providing +12 VDC output to, “Childminder Alarm, J1-3.
 - PCB-02015, power center will begin to alternate horn and interior outputs.
 - Reset Switch backlight, will alternate.
4. Disarming Childminder System.
 - Depressing, “Reset Switch”, located in school bus rear door area.
 - Note: Depressing, “Reset Switch”, prior to removing vehicle ignition will not enable, Alarm Enable described in step 3.

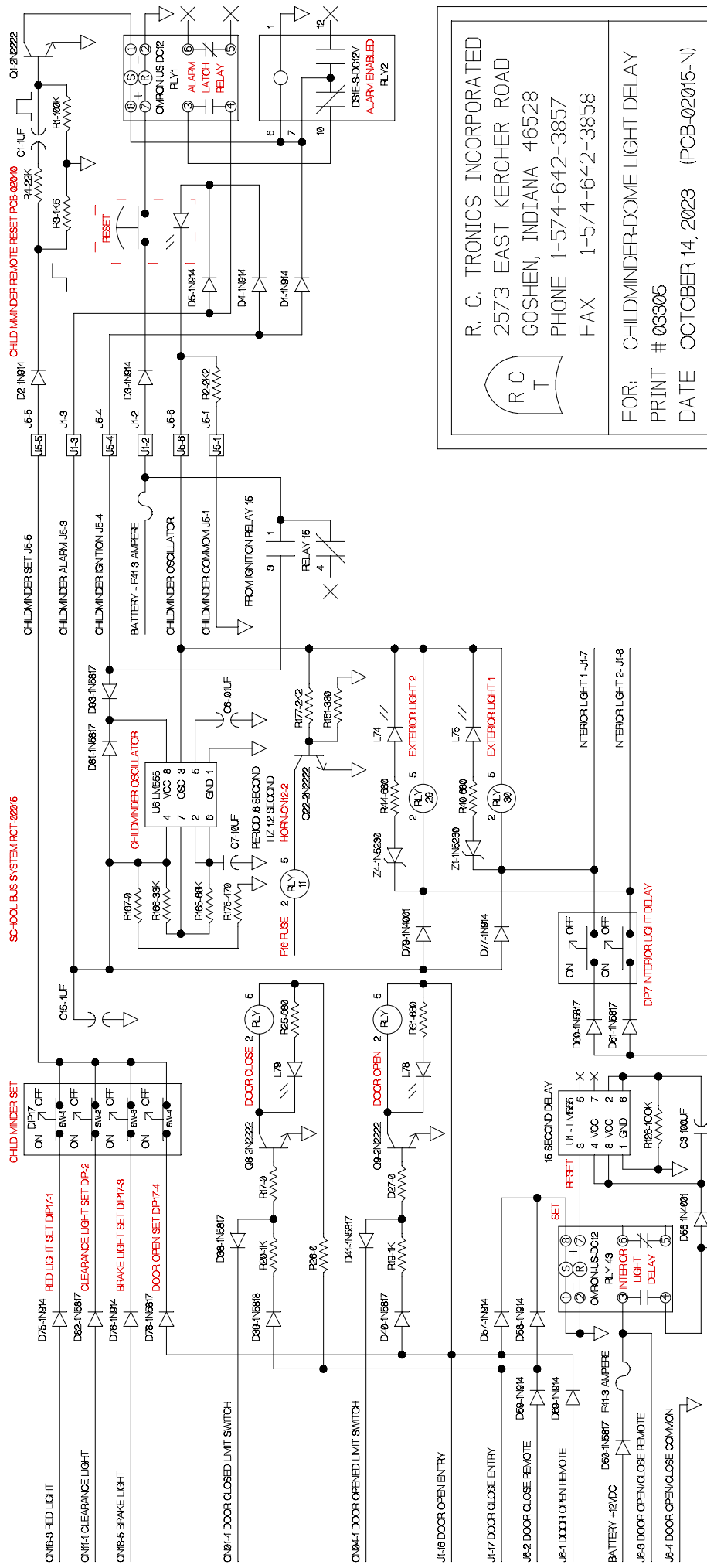

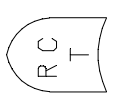
 R. C. TRONICS INCORPORATED
 2573 EAST KERCHER ROAD
 GOSHEN, INDIANA 46528
 PHONE 1-574-642-3857
 FAX 1-574-642-3858

FOR: CHILD MINDER-DOME LIGHT DELAY
 PRINT # 083005
 DATE OCTOBER 14, 2023 (PCB-02015-N)

R. C. Tronics, Incorporated

2573 East Kercher Road
Goshen, Indiana 46528
Toll Free: 1-886-457-7790

Phone: 1-574-642-3857
Facsimile: 1-574-642-3858
<https://www.rctronics.com>

CROSSING ARM TIMER – STOP SIGN DEPLOY – PCB-02015-R **Monday, October 23, 2023**

Circuit Description and Operation:

**THE CIRCUIT OPERATION BELOW WILL NOT PERMIT CROSSING
ARM OR OTHER CLOSE OBSTRUCTIONS TO DAMAGE BY
EXTENSION OF CROSSING ARM.**

BEGIN TEN SECOND DELAY AND INPUT CN03-3.

- Providing 12 DVC input at CN03-3 provides 12 VDC output at CN15-1 to extend crossing arm (STOP SIGN).
- Inputting an input from, PCB-01919 SW9, “Electric Door Close”, switch, via DIP-12 switch 1 or with optional, SW5, “H/Mirror”, via DIP-12 switch 2 will provide a ten second delay.
- **Option:** PCB-02195-A, “Crossing Arm Delay Switch”, provides ten second delay, when connected from J1 to J3 on PCB-02015-R.
- During this delay period, input into CN03-3 will not permit an output at CN15-1.
- Providing 12 DVC input at CN03-3 provides 12 VDC output at CN03-1 and CN03-2, without delay.

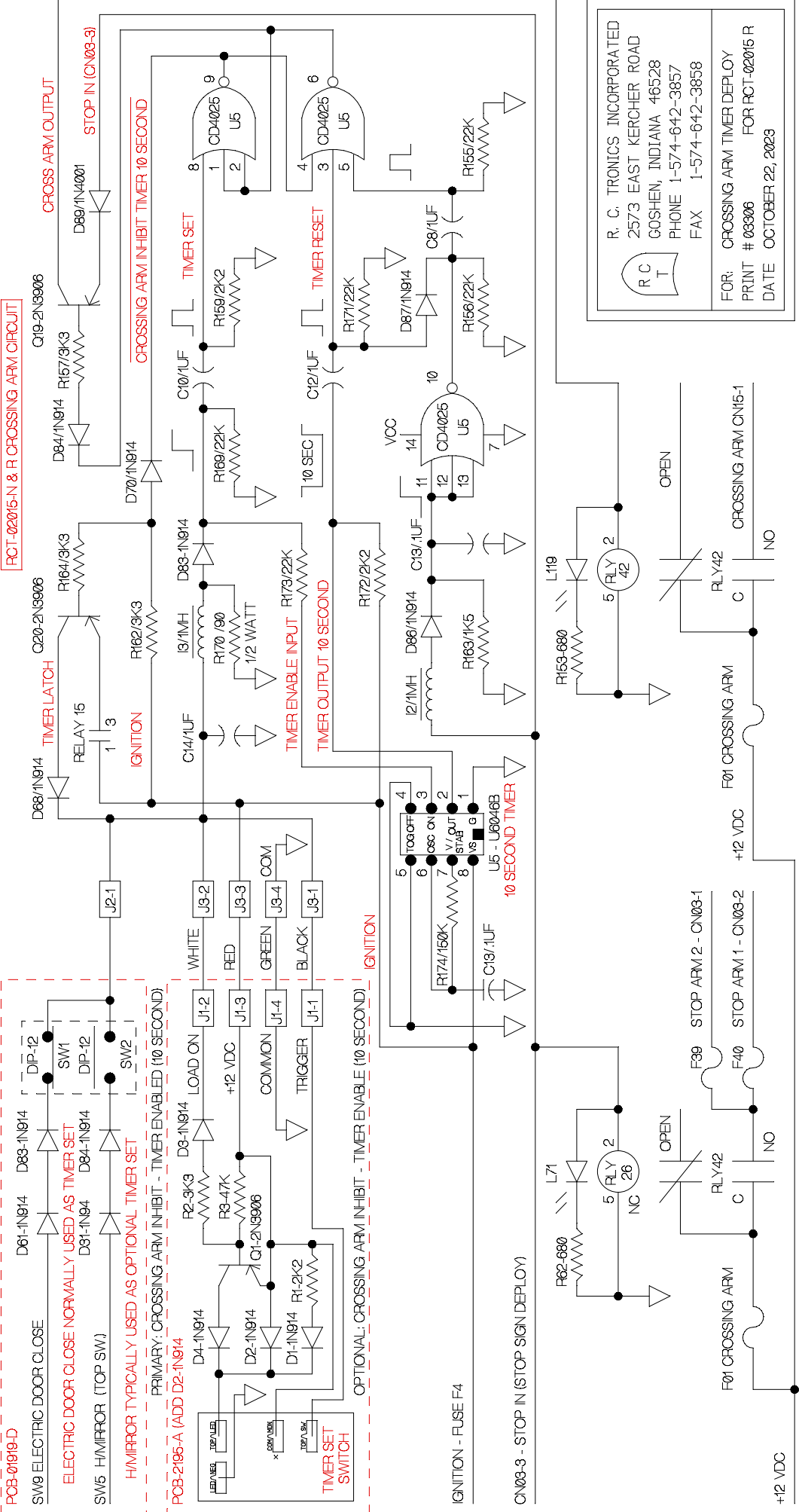

R C T

R. C. TRONICS INCORPORATED
 2573 EAST KERCHER ROAD
 GOSHEN, INDIANA 46528
 PHONE 1-574-642-3857
 FAX 1-574-642-3858

FOR: CROSSING ARM TIMER DEPLOY
 PRINT # 033006 FOR RCT-02015 R
 DATE OCTOBER 22, 2023

R. C. Tronics, Incorporated

2573 East Kercher Road
Goshen, Indiana 46528
Toll Free: 1-886-457-7790

Phone: 1-574-642-3857
Facsimile: 1-574-642-3858
<https://www.rctronics.com>

LIMIT SWITCH 1 THRU 6 – PCB-02015-N

Saturday, October 28, 2023

LIMIT SWITCH INPUTS 1 THRU 6.

- DIP-1: ALARM 1 CN7-1, LIMIT SWITCH INPUT (SINK).
- DIP-2: ROOF HATCH CN7-2, LIMIT SWITCH INPUT (SINK).
- DIP-3: REAR DOOR CN7-3, LIMIT SWITCH INPUT (SINK).
- DIP-4: EGRESS WINDOW CN7-4, LIMIT SWITCH INPUT (SINK).
- DIP-5: LIFT DOOR CN7-5, LIMIT SWITCH INPUT (SINK).
- DIP-6: VANDAL LOCK CN7-6, LIMIT SWITCH INPUT (SINK).

LIMIT SWITCH OUTPUTS 1 THRU OUTPUT 6.

- DIP-1: ALARM 1 J2-06, LIMIT SWITCH OUTPUT (+12 VDC).
- DIP-2: ROOF HATCH J2-05, LIMIT SWITCH OUTPUT (+12 VDC).
- DIP-3: REAR DOOR J2-07, LIMIT SWITCH OUTPUT (+12 VDC).
- DIP-4: EGRESS WINDOW J2-08, LIMIT SWITCH OUTPUT (+12 VDC).
- DIP-5: LIFT DOOR CN7-5J2-09, LIMIT SWITCH OUTPUT (+12 VDC).
- DIP-6: VANDAL LOCK J2-10, LIMIT SWITCH INPUT OUTPUT (+12 VDC).

CIRCUIT FUNCTION.

Inputs, sinking, for each of six inputs via limit switches provided by CN7 connector.

Outputs, sourcing, for each of six are present too, J2-5 through J2-10.

These signals are routed via data cable to PCB-01919-D, J11-J6-J9-J5-J4 & J3, respectively.

Each output, sourcing (+12 VDC) can be selected with DIP Switch 1 through 6. Those choices are, "IGNITION 1 – MASTER 2 – BATTERY 3.

NOTE:

DIP-5, Lift Door buzzers disabled to both on PCB-02015-N and PCB-01919-D, with a sinking input to, "PARK BRAKE" at, CN08-1 & J4-4.

R. C. Tronics, Incorporated

2573 East Kercher Road
Goshen, Indiana 46528
Toll Free: 1-886-457-7790

Phone: 1-574-642-3857
Facsimile: 1-574-642-3858
<https://www.rctronics.com>

DIP SWITCH TEST PROCEDURE FOR SCHOOL BUS CONTROL PCB-02015-N. **Tuesday, October 31, 2023**

DIP 1 - Alarm 1 (All four Dip Switches "OFF").

- Sink at CN17-1.
- Set Dip Switch 4, "ON".
- Set Dip Switch 3, "ON" = Led, "ON" with Alarm.
- Set DIP Switch 3, "OFF" = Led "OFF" with Alarm.
- Connect, Ignition, +12 VDC to CN11-3.
- Set DIP Switch 2, "ON".
- Test Fixture, operate, Master Switch, "ON & OFF".
- Alarm 1 Led, "ON & OFF" with Alarm, (Follows operation of, Master Switch on Test Fixture).
- Test Fixture, place Master Switch, "OFF".
- Set DIP Switch 2, "OFF".
- Set DIP Switch 1, "ON". = Led, "ON" with Alarm.
- Remove Ignition, +12 VDC at CN11-3
- Remove Sink at CN17-1.

DIP 2 – Roof Hatch (All four Dip Switches "OFF").

- Sink at CN17-2.
- Set Dip Switch 4, "ON".
- Set Dip Switch 3, "ON" = Led, "ON" with Alarm.
- Set DIP Switch 3, "OFF" = Led "OFF" with Alarm.
- Connect, Ignition, +12 VDC to CN11-3.
- Set DIP Switch 2, "ON".
- Test Fixture, operate, Master Switch, "ON & OFF".
- Alarm 1 Led, "ON & OFF" with Alarm, (Follows operation of, Master Switch on Test Fixture).
- Test Fixture, place Master Switch, "OFF".
- Set DIP Switch 2, "OFF".
- Set DIP Switch 1, "ON". = Led, "ON" with Alarm.
- Remove Ignition, +12 VDC at CN11-3
- Remove Sink at CN17-2.

DIP 3 – Rear Door (All four Dip Switches "OFF").

- Sink at CN17-3.
- Set Dip Switch 4, "ON".
- Set Dip Switch 3, "ON" = Led, "ON" with Alarm.
- Set DIP Switch 3, "OFF" = Led "OFF" with Alarm.
- Connect, Ignition, +12 VDC to CN11-3.
- Set DIP Switch 2, "ON".
- Test Fixture, operate, Master Switch, "ON & OFF".

- Alarm 1 Led, “ON & OFF” with Alarm. (Follows operation of, Master Switch on Test Fixture).
- Test Fixture, place Master Switch, “OFF”.
- Set DIP Switch 2, “OFF”.
- Set DIP Switch 1, “ON”. = Led, “ON” with Alarm.
- Remove Ignition, +12 VDC at CN11-3
- Remove Sink at CN17-3.

DIP 4 – Egress Window (All four Dip Switches “OFF”).

- Sink at CN17-4.
- Set Dip Switch 4, “ON”.
- Set Dip Switch 3, “ON” = Led, “ON” with Alarm.
- Set DIP Switch 3, “OFF” = Led “OFF” with Alarm.
- Connect, Ignition, +12 VDC to CN11-3.
- Set DIP Switch 2, “ON”.
- Test Fixture, operate, Master Switch, “ON & OFF”.
- Alarm 1 Led, “ON & OFF” with Alarm. (Follows operation of, Master Switch on Test Fixture).
- Test Fixture, place Master Switch, “OFF”.
- Set DIP Switch 2, “OFF”.
- Set DIP Switch 1, “ON”. = Led, “ON” with Alarm.
- Remove Ignition, +12 VDC at CN11-3
- Remove Sink at CN17-4.

DIP 5 – Lift Door (All four Dip Switches “OFF”).

- Sink at CN17-5.
- Set Dip Switch 4, “ON”.
- Set Dip Switch 3, “ON” = Led, “ON” - Flood Light, “ON” at CN14-1 – Lift Door Alarm, “ON”.
- Set DIP Switch 3, “OFF” = Led “OFF”, Flood Light, “OFF” at CN14-1 – Lift Door Alarm, “OFF”.
- Connect, Ignition, +12 VDC to CN11-3.
- Set DIP Switch 2, “ON”.
- Test Fixture, operate, Master Switch, “ON”,
- Led, “ON” - Flood Light, “ON” at CN14-1 – Lift Door Alarm, “ON”.
- Test Fixture, place Master Switch, “OFF”.
- Led, “OFF” - Flood Light, “OFF” at CN14-1 – Lift Door Alarm, “OFF”.
- Set DIP Switch 2, “OFF”.
- Set Dip Switch 1, “ON”. = Led, “ON” - Flood Light, “ON” at CN14-1 – Lift Door Alarm, “ON”.
- Sink, “Park Brake @ CN08-1 = Removes Alarm for “Lift Door Open”.
- Remove Ignition, +12 VDC at CN11-3.
- Remove Sink at CN17-5.

DIP 6 – Vandal Lock (All four Dip Switches “OFF”).

- Sink at CN17-6.
- Set Dip Switch 4, “ON”.
- Set Dip Switch 3, “ON” = Led, “ON” with Alarm.
- Set DIP Switch 3, “OFF” = Led “OFF” with Alarm.
- Connect, Ignition, +12 VDC to CN11-3.
- Set DIP Switch 2, “ON”.

- Test Fixture, operate, Master Switch, "ON & OFF".
- Alarm 1 Led, "ON & OFF" with Alarm. (Follows operation of, Master Switch on Test Fixture).
- Test Fixture, place Master Switch, "OFF".
- Set DIP Switch 2, "OFF".
- Set DIP Switch 1, "ON". = Led, "ON" with Alarm.
- Remove Ignition, +12 VDC at CN11-3
- Remove Sink at CN17-6.

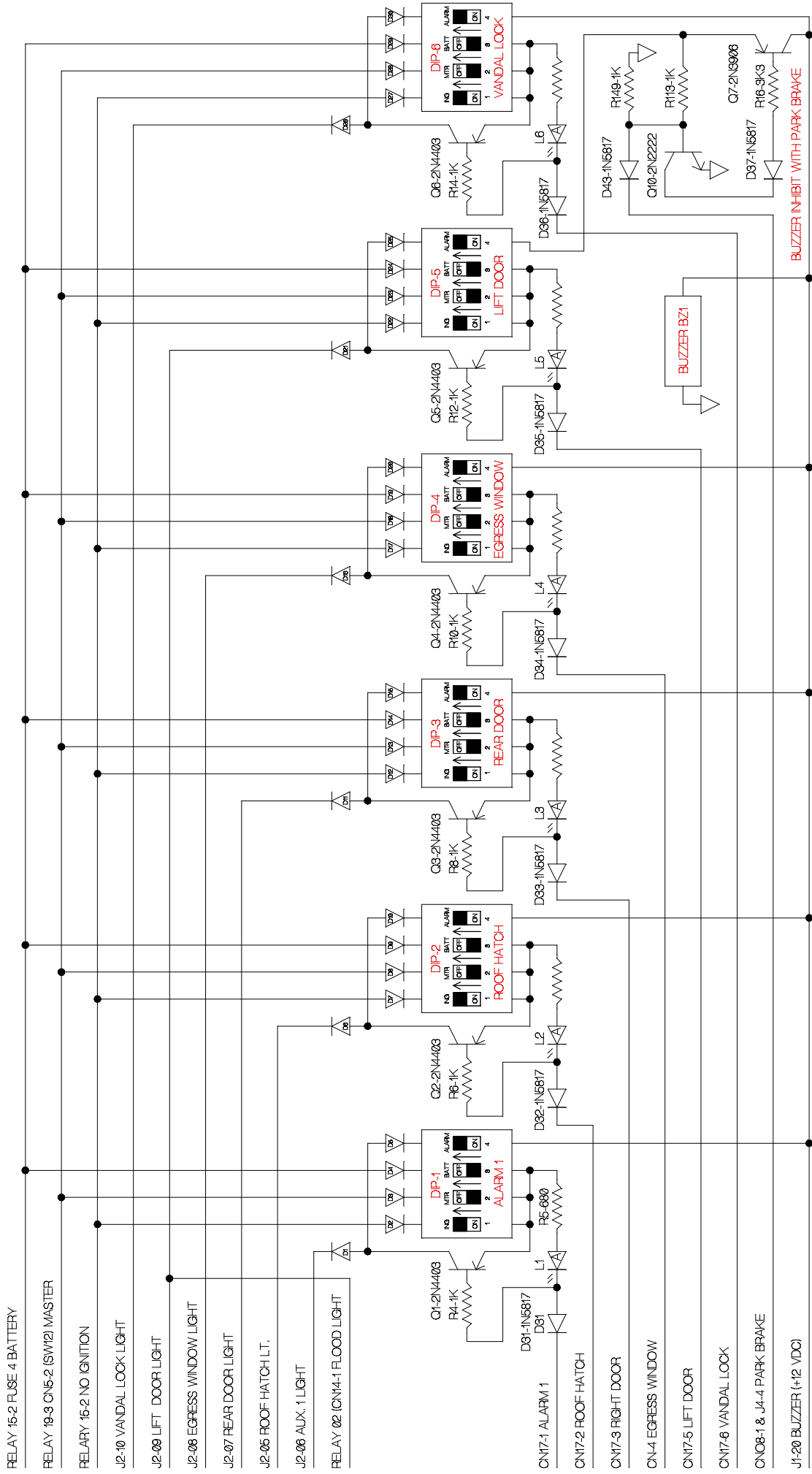



 R. C. TRONICS INCORPORATED
 2573 EAST KERCHER ROAD
 GOSHEN, INDIANA 46528
 PHONE 1-574-642-3857
 FAX 1-574-642-3858
 FOR: 02015-N LIMIT SWITCH PRINT
 PRINT # 03907
 DATE 0CTOBER 28, 2023

R. C. Tronics, Incorporated

2573 East Kercher Road
Goshen, Indiana 46528
Toll Free: 1-886-457-7790

Phone: 1-574-642-3857
Facsimile: 1-574-642-3858
<https://www.rctronics.com>

TEST PCB-02015-R CHILDMINDER, CROSSING ARM AND SWITCH FIXTURE.

Wednesday, November 1, 2023

IGNITION IN, +12 VDC to, CN11-3.

- Ignition Output LEDs, "ON" at CN10-1, CN13-4 through CN13-1 and CN14-5 through CN14-3.

STOP ARM TEST.

- Test Fixture, input +12 @ Stop in CN03-3, NOTE, output at led output @ Stop Arm 1 and 2, CN03-1 and CN03-2.
- Remove +12 VDC @ CN03-3.
- Test Fixture, operate door switch close, NOTE, on test fixture, Stop Arm Cancel switch indicator will illuminate for 10 seconds. During this delay period input +12 VDC @ Stop IN CN03-3, NOTE, output only at CN03-1 and CN03-2.

NO CHILD LEFT BEHIND.

- DIP17-SW1, set "ON", (Red Light)
- Red Input, +12 VDC to CN18-3.
- Remove, Ignition In, +12 vdc to, CN11-3. NOTE, outputs CN02-3&4 (SW-4&3) and CN12-2 (Clearance Light), will alternate.
- Test fixture, operate switch, No Child Let Behind. NOTE, circuit reset.

- DIP17-SW2, set "ON", (Clearance Light)
- Ignition Input, +12 VDC to CN18-3.
- Remove, ignition in, +12 vdc to, CN11-3. NOTE, outputs CN02-3&4 (SW-4&3) and CN12-2 (Clearance Light), will alternate.
- Test fixture, operate switch, No Child Let Behind. NOTE, circuit reset.

- DIP17-SW3, set "ON", (Brake Light)
- BK/LT Input, +12 VDC to CN18-5.
- Remove, ignition in, +12 vdc to, CN11-3. NOTE, outputs CN02-3&4 (SW-4&3) and CN12-2 (Clearance Light), will alternate.
- Test fixture, operate switch, No Child Let Behind. NOTE, circuit reset.

- DIP17-SW4, set “ON”, (Entry Door Open).
- Test Fixture, operate, Door switch Open.
- Remove, ignition in, +12 vdc to, CN12-3. NOTE, outputs CN02-3&4 (SW-4&3) and CN12-2 (Clearance Light), will alternate.
- Test fixture, operate switch, No Child Let Behind. NOTE, circuit reset.
- Note, set DIP17, Switches 1 through 4, “ON”.

Test Fixture, Interior Light 1, Switch 3 and Fifteen Second Delay.

- IGNITION IN, +12 VDC to, CN11-3.
- Ignition Output LEDs, “ON” at CN10-1, CN13-4 through CN13-1 and CN14-5 through CN14-3.
- Test Fixture, operate, Interior Light 1, NOTE, output @ CN02-4, SW-3.
- Set, DIP7-SW2, “ON”, (Interior Light Delay, 15 second).
- Test Fixture, operate, Door Open or Close, Switch 9. Dome Light Delay @ CN02-4 will delay, “OFF”.

Test Fixture, Interior Light 2, Switch 4 and Fifteen Second Delay.

- IGNITION IN, +12 VDC to, CN11-3.
- Ignition Output LEDs, “ON” at CN10-1, CN13-4 thru CN13-1 and CN14-5 thru CN14-3.
- Test Fixture, operate, Interior Light 2, NOTE, output @ CN02-3, SW-4.
- Set, DIP7-SW1, “ON”, (Interior Light Delay, 15 second).
- Test Fixture, operate, Door Open or Close, Switch 9. Dome Light Delay @ CN02-4 will delay, “OFF”.

Test Fixture, Wig Wag, Switch 5, Top & Bottom.

- IGNITION IN, +12 VDC to, CN11-3.
- Test Fixture, Wig Wag, SW-5 top. NOTE, output @ CN02-2.
- Test Fixture, Wig Wag, SW-5 bottom. NOTE, output @ CN02-1.

Test Fixture, Heated Mirror, Switch 6, Top & Bottom.

- IGNITION IN, +12 VDC to, CN11-3.
- Test Fixture, Heated Mirror, SW-6 top. NOTE, output @ CN04-5.
- Test Fixture, Heated Mirror, SW-6 bottom. NOTE, output @ CN04-4.

Test Fixture, Amber Cancel, Switch 7, Top & Bottom.

- IGNITION IN, +12 VDC to, CN11-3.
- Test Fixture, Amber Cancel, SW-7 top. NOTE, output @ CN04-3.
- Test Fixture, Amber Cancel, SW-7 bottom. NOTE, output @ CN04-2.

Test Fixture, Noise Removal, SW-8.

- IGNITION IN, +12 VDC to, CN11-3.

- Set, DIP Switch 8 and 9, "OFF". (Ignition to Noise Cancel).
- Test Fixture, operate, Noise Removal, Switch 8, "ON".
- Noise Removal output, "ON" @ SW-1, CN04-1 (+12 VDC).
- Noise Removal output, "OFF", CN13-3 & 4 ("Labeled Ignition 2 & 3"), (+12 VDC).
- Set, DIP Switch 8 and 9, "ON". Back to, (Ignition from Noise Cancel).
- Positive Probe, check CN09-1 thru 4. Note, positive probe no light indication.
- Test Fixture, operate, Noise Removal, Switch 8, "OFF". NOTE, with positive probe, recheck CN09-1 through 4, positive probe light, "ON".

Fan Blower, High, Medium, and Low at J3.

- Set, DIP10 Switch 1, "ON".
- Set, Blower Low, "ON", sink @ J3-3, NOTE, Fan Low output @ CN10-2.
- Set, Blower Medium, "ON", sink, J3-2, NOTE, Fan Medium output @ CN06-1.
- Set, Blower High, "ON", sink, J3-2, NOTE, Fan High output @ CN06-2.
- Set, DIP10 Switch 1, "OFF". NOTE, operation of blower, low, medium, and high will not operate with, Noise Removal Switch, SW1, "ON".

Test Fixture, Door Open, SW-9.

- Remove, IGNITION IN, +12 VDC to, CN11-3
- Set, DIP7-Switch 1 & 2, "ON".
- Set, DIP11-Switch 1, "OFF".
- Test Fixture, operate Door Open, SW09. Note, Output, Door Open CN01-2 & CN02-3 & 4 (Dome Light Delay, 15 Second).
- Test Fixture, operate Door Open, SW09, sink Door Open Limit @ CN01-4, output will be removed.
- Set, DIP11-Switch 1, "ON".
- Test Fixture, operate Door Open, SW09. Note, Hold, Door Open Switch, then sink, CN08-2, Transmission in Park, door will open.

Test Fixture, Door Close, SW-9.

- Set, DIP11-Switch 1, "OFF".
- Test Fixture, operate Door Close, SW09. Note, Output, Door Close CN01-2 & CN02-3 & 4 (Dome Light Delay, 15 Second).
- Test Fixture, operate Door Close, SW09, sink Door Close Limit @ CN01-4, output will be removed.

Test Fixture, Amber Lights, SW-10.

- IGNITION IN, +12 VDC to, CN11-3
- Test Fixture, operate Amber Lights, SW10. NOTE, output @ SW10, CN03-5.

Test Fixture, Master Switch, SW-11.

- IGNITION IN, +12 VDC to, CN11-3
- Test Fixture, operate Master Switch, SW10. NOTE, output @ SW10, CN03-5.

Test Fixture, Override 8-Way Flashers, SW-1.

- IGNITION IN, +12 VDC to, CN11-3
- Test Fixture, operate Override 8-Way Flashers, SW1. NOTE, output @ SW1, CN02-6.

Test Fixture, Wheelchair Lift SW-12, ADA & Shift Lock.

- IGNITION IN, +12 VDC to, CN11-3.
- Test Fixture, Wheelchair Lift, switch 12," ON", NOTE, output SW-12 @ CN05-1, Lift Lock, Red led, "ON" (L118) and Lift Switch Amber Led, "ON" (L113).
- Sink Lift Door @ CN17-5, Note, Amber Lift Led, "ON" (L114) with Audible buzzer.
- Sink, Park Brake @ CN08-1, Note, Amber Led Park Brake Led, "ON" and Audible Buzzer silenced.
- Sink, Transmission In Park @ CN08-2, Note, Amber Led, "ON" and Green Led, "ON", (L117), ADA and Shift Lock Enabled.

Test Fixture, Strobe, SW-2.

- IGNITION IN, +12 VDC to, CN11-3
- Test Fixture, operate Strobe, SW. NOTE, output @ SW1, CN02-5.

R.C. Electronics Incorporated

SPECIALIZING IN ELECTRONIC CONTROLS

2573 East Kercher Road GOSHEN, IN 46528
Phone 1-574-642-3857 Fax 1-574-642-3858
Toll Free 1-866-457-7790 <http://www.rcelectronics.com>

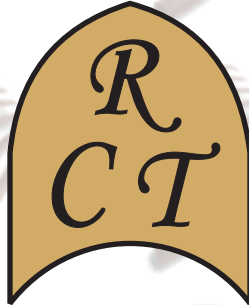

Custom Design of Electronic Controls

Speciality Vehicles

Fire Apparatus Systems
Police Vehicle Systems
Transit Bus Systems
Ambulance Systems

Printed Circuit Board Layout

Computer Generated Artwork
FR-4 PCB Material
Double-Sided Plated-Thru Hole

Complete Manufacturing Facility

New Era Wave Soldering Machine
Technical Devices PCB Cleaner
Automated PCB Insertion Equipment
Universal Laser System, Custom Faceplates
K .F. Hot Stamp Machine

Permit us to solve your Electrical / Electronic Control needs.